

FTN198...

LIMIT SWITCH WITH PULL RING

Thermoplastic limit switch
Vertical action
Adjustable head (90° steps)
Electrically independent contacts (Zb)
Enclosure IP rating: IP67
Compliance: EN 50047, IEC/EN 60947-5-1, UL 508, up to SIL3
Marking: CE, CCC, UL, EAC, UKCA

F T N

Series
FTN thermoplastic limit switch

1

Type
1 standard

9 8

Head and actuator
98 pull ring

X 1 1

Contact type
X11 1NO/1NC slow action Zb
W02 2NC slow action Zb
W20 2NO slow action Zb
Z11 1NO/1NC snap action Zb
Z02 2NC snap action Zb
W12 1NO/2NC slow action Zb
W03 3NC slow action Zb

Lead exit dimension or type
blank M16 (standard)
M M20
G3 PG13.5
C 4 poles male code "A" M12x1 connector



Positive opening operation		NC contact
Minimum current		5 mA - 5 V DC
Thermal current	lth	10 A
Rated insulation voltage	Ui	500 V
Rated impulse withstand voltage	Uimp	6 kV
Insulation resistance	min	100 MΩ (DC 500 V)
Contact resistance	max	25 mΩ (initial)
Enclosure material		glass filled PBT (UL approved)
Enclosure degree of protection		IP67
Operating temperature		-25 ... +80°C (-13 ... +176°F)
Pollution degree		3
Protection against electric shock		class II (double insulation)
Mechanical life expectancy	min	1×10 ⁷ cycles
Electrical life expectancy	min	150000 cycles
Vibration	IEC 68-2-6	10-55 ±1 Hz
	excursion	0.35 mm, 1 octave/min
Fixing		2 × M4 screws

FTN198...

Contact types	Categories *	Ratings **	PT1	PT2	OF	TT
X11 1NO 1NC			3.5 mm	-	20 N	
W02 2NC	slow action (Zb) A600 - Q600		3.5 mm	-	20 N	
W20 2NO		AC15: 400 V - 4 A	3.6 mm	3.6 mm	20 N	
Z11 1NO 1NC	snap action (Zb) B600 - Q600		4.5 mm	3.5 mm	20 N	8.0 mm
Z02 2NC		DC13: 24 V - 6 A	4.5 mm	3.3 mm	20 N	
W12 1NO 2NC	slow action (Zb) A300 - Q300		3.5 mm	-	20 N	
W03 3NC			3.5 mm	-	20 N	

* UL 508 / CSA C22-2 n° 14 ** IEC/EN 60947-1

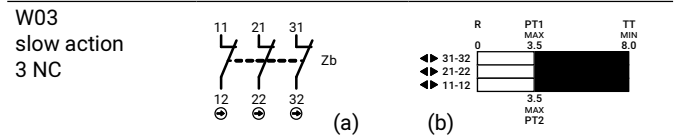
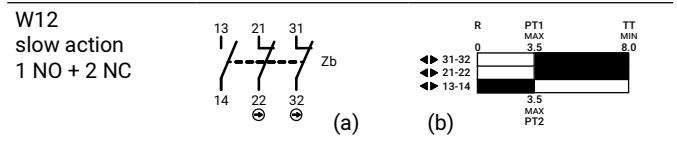
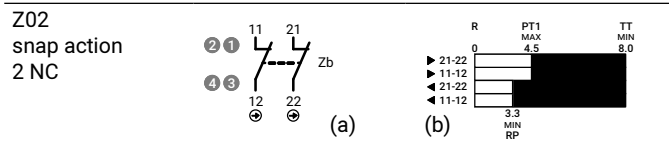
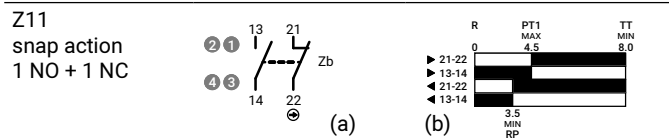
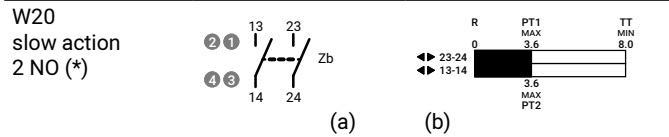
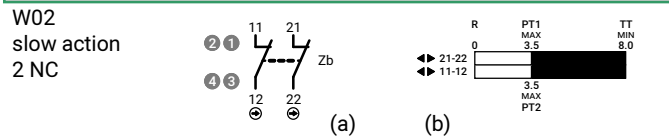
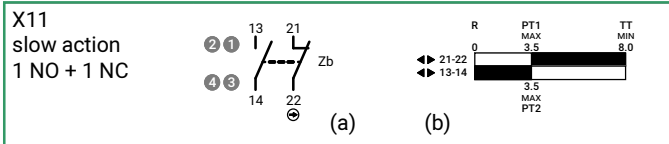

(*) Not suitable for safety applications.

(a) Maximum traction position
(b) Rest position

PT1 Operating travel

PT2 Second operating travel (slow action)

RP Release position (snap action)

OF Operating force

TT Total travel



M12 Connector pin arrangement - on request

(1) Mounting holes

Dimensions in mm / illustrations NOT in scale

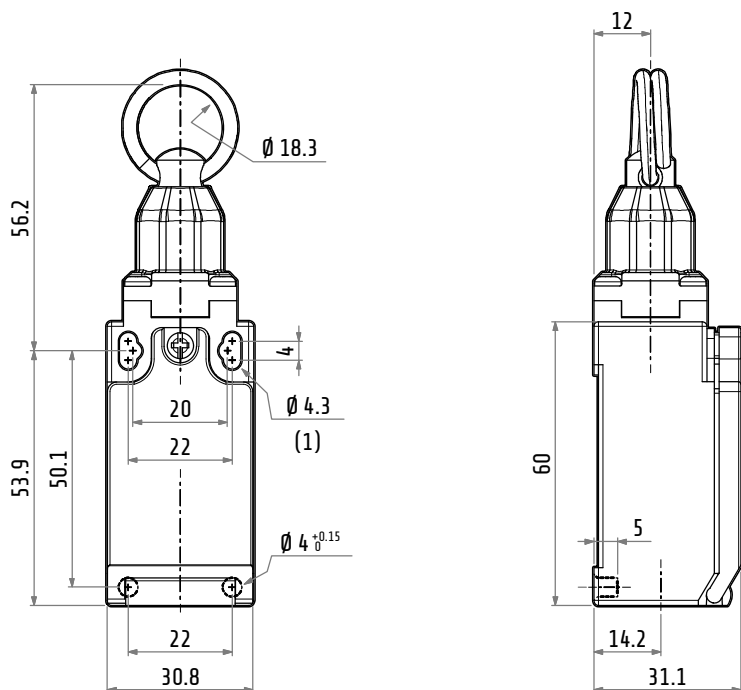

The FTN198 has not a maintained operating mode. This means that a bistable relay (B.R.) must be inserted in the system in order to maintain the state. Example:

